



TERRAFORM SERIES

AC INFINITY

WELCOME

Thank you for choosing AC Infinity. We are committed to product quality and friendly customer service. If you have any questions or suggestions, please don't hesitate to [contact](#) us. Visit www.acinfinity.com and click contact for our contact information.

EMAIL

support@acinfinity.com

WEB

www.acinfinity.com

LOCATION

Los Angeles, CA

MANUAL CODE ACN2407X1

PRODUCT

TERRAFORM 7

MODEL

AC-ACN5

UPC-A

819137024373

MANUAL INDEX

| | |
|---|----------------|
| Manual Index | Page 5 |
| Product Warning | Page 6 |
| Key Features | Page 10 |
| Product Contents | Page 11 |
| Configuration Setup | Page 12 |
| Installation | Page 17 |
| Powering and Setup | Page 28 |
| Maintenance | Page 29 |
| UIS™ Platform | Page 31 |
| UIS™ Compatibility | Page 32 |
| Connecting to UIS™ | Page 33 |
| Programming | Page 34 |
| Cool Function | Page 38 |
| Dry Function | Page 42 |
| Fan Function | Page 46 |
| Heat Function | Page 48 |
| Other Settings | Page 57 |
| FAQ | Page 59 |
| Other AC Infinity Products | Page 60 |
| Warranty | Page 61 |

PRODUCT WARNING



This product is intended to cool, heat, dehumidify, and circulate the air in indoor spaces only. This product is not intended for commercial or industrial use. Use this product only as described in this manual.

TO REDUCE THE RISK OF FIRE, ELECTRIC SHOCK, OR INJURY TO PERSONS, OBSERVE THE FOLLOWING:

1. Read all instructions before installing and using this product.
2. This product is not intended for users who lack experience with and knowledge of this product, children, or those with reduced physical, sensory, or mental capabilities, unless under supervision by a qualified individual responsible for their safety.
3. Extreme caution is required before leaving this product operating unattended. Ensure that all warnings have been properly followed and your environment is free of any potential safety hazards. This product must be operated in the upright position only.
4. If you are unfamiliar or have doubts about performing this product's installation, seek the services of a qualified, trained, and licensed professional. Inappropriate installation will void this product's warranty.
5. Do not attempt to hardwire this product. Performing any retrofitting actions may result in personal injury and/or electrical damage, and will void this product's warranty.
6. This product is hot when the heating element isn't in use. To avoid burns, do not let bare skin touch hot surfaces.
7. This product must not be used in potentially hazardous locations such as flammable, explosive, chemical-laden, or wet atmospheres. This includes areas containing gasoline, paint, and additional flammable liquids.
8. Do not use this product outdoors, in direct sunlight, or expose it to weather or elements.
9. Do not use this product in areas where oil or water are likely to splash.

PRODUCT WARNING



10. Plug this product directly into a wall outlet. Never use with an extension cord or relocatable power tap (outlet/power strip). Do not use this product on a surge-protected unit or Ground Fault Circuit Interrupted (GFCI) outlet.
11. Do not cover this product or the power cords with rugs or other fabric materials. Do not route cords under furniture or appliances. The cord should not hang over edges or be placed where it can be bent or closed in doors. Place this product near an easily accessible outlet so the product can be unplugged quickly during an emergency.
12. Do not operate this product if it malfunctions, has been dropped, or is damaged in any manner. Do not operate this product if its cord malfunctions or is damaged in any manner.
13. Do not depend on the on/off programming as the sole means of shutting power from this product. Unplug the power cord before installing, servicing, or moving this product. Unplug this product when it is not in use. Do not yank, strain, stretch, or wet the power cord.
14. Clean this product regularly, only as instructed in this manual. Prior to cleaning, turn off the power and unplug the cord. Do not use gasoline, thinners, solvents, ammonias, or other chemicals for cleaning.
15. In order to avoid water leakage, empty the condensation tray before moving the product. Refer to the Maintenance section for instructions.
16. Before plugging the power cord into an outlet, make sure that all electrical information on the product labels, including voltage, is compatible with your outlet's power supply.
17. Place this product at least 3 feet away on all sides from walls, outlets, furniture, pillows, bedding, papers, clothes, curtains and other objects that may cause or catch fire. Do not place it near any flammable objects that may fall off and catch fire.
18. Do not place this product on a soft, elevated, or unstable surface, or in any location where it may fall over or air intakes or exhaust can be blocked in any manner.
19. No part of this product should be placed near furnaces, fireplaces, stoves, or other high temperature heat sources. Do not use in windows, uneven or unstable surfaces, or near water.

PRODUCT WARNING



20. Do not tilt, incline, or lay this product on its side or back.
21. The applicable operating temperature range for this product is 41-95°F.
22. Do not operate with a solid state speed device, such as a dimmer control switch. Use of this product on the same electrical circuit as another high-energy use product, such as vacuums, blenders, variable speed fans, or circulators is not advised.
23. Never ignore signs of an electrical problem, such as: warn outlet cover plates, sparks when plugging or operating, lights flickering/dimming during operation. Immediately turn off and unplug this product if any such problems are noticed. Contact a qualified electrician to investigate possible causes before operating this product again.
24. Do not insert or allow fingers or foreign objects to enter any ventilation or exhaust openings as it may cause electric shock, fire, or damage to this product. Do not block or tamper with this product in any manner while it is in operation.
25. Do not operate this product if it does not produce a steady stream of cold or hot air from their respective vents after 5 minutes of continuous operation.
26. Do not open this product's housing while the product is plugged in.

DO NOT attempt to repair this product yourself!

All service and/or repairs must be done by an authorized technician and/or electrician. Contact our customer service department at support@acinfinity.com or (626) 923-6399 for product and warranty assistance.

PRODUCT WARNING

REFRIGERANT (R32)



Read all instructions before installing and using this product. Be aware that refrigerants may not contain an odor. All safety precautions must be followed. When defrosting and cleaning this product, only use this product as described in this manual.

FLAMMABLE REFRIGERANT USED. TO REDUCE THE RISK OF FIRE, EXPLOSION, OR INJURY TO PERSONS, OBSERVE THE PREVIOUS WARNINGS IN ADDITION TO THE FOLLOWING:

1. This product and any ducting connected to it must be stored and used in a well-ventilated area.
2. Individuals who operate or work on the refrigerant circuit must have the appropriate certification issued by an accredited organization that ensures competence in handling refrigerants according to a specific evaluation recognized by associations in the industry.
3. Do not puncture refrigerant tubing.
4. Dispose of product properly in accordance with federal or local regulations. Handle carefully in compliance with national regulations.

DO NOT attempt to repair this product yourself!

All service and/or repairs must be done by an authorized technician and/or electrician. Contact our customer service department at support@acinfinity.com or (626) 923-6399 for product and warranty assistance.

KEY FEATURES

ALL-IN-ONE DEVICE

Effortlessly adapts to provide effective cooling, heating, and dehumidification to a wide array of interior spaces.

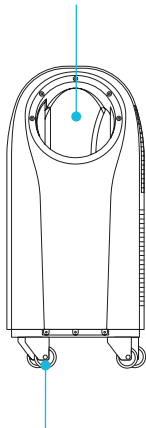

PORTABLE BUILD

Built to work with grow spaces and can be placed anywhere for greater accessibility.

UIS™ COMPATIBLE

Pairs with our smart controllers to allow app control as part of our UIS platform to help create the ideal grow environment.

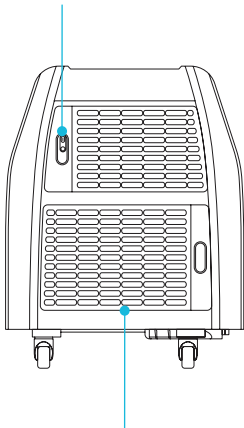

CUSTOMIZABLE

All intake and exhaust vents can be positioned for a stronger performance while maximizing efficiency.

SMART CONTROLLER

Features custom controls that activate your AC based on temperature, humidity, and VPD triggers.

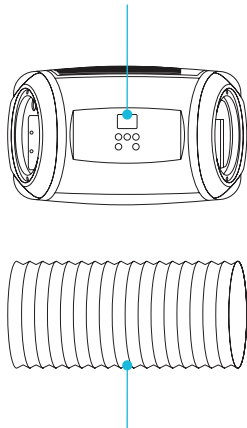

PRESSURE CONTROL

Easy-to-adjust ducting creates the potential for negative, neutral, or positive pressure environments.

PRODUCT CONTENTS

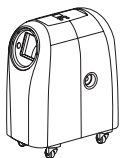

PORTABLE AIR
CONDITIONER
(x1)

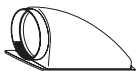

EVAPORATOR
DUCT ADAPTER
(x1)

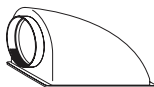

CONDENSER
DUCT ADAPTER
(x1)

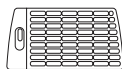

EVAPORATOR
FRAME
(x1)

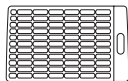

CONDENSER
FRAME
(x1)



DUCT ADAPTER
BASE
(x2)



SHUTTER
COUPLER
(x1)



DUCT
COUPLER
(x2)



WINDOW DUCT
ADAPTER
(x2)



WINDOW BASE
COUPLER
(x2)



WINDOW DUCT
MAIN PLATE
(x2)



TRACK
PLATE
(x2)



SEAL
TAPE
(x1)



BOLTS AND
WING NUTS
(x4)

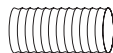

DUCTING,
5 FT.
(x2)

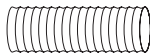

DUCTING,
6.5 FT.
(x2)



DRAIN
PIPE
(x1)



SENSOR
PROBE
(x1)

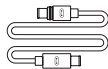

UIS EXTENSION
CORD (M-M)
(x1)



WIRE
TIE
(x1)

CONFIGURATION SETUP

COOLING OR HEATING YOUR SPACE

Before installing and routing ducting from your air conditioner, first determine whether you want a warmer or cooler space. Then ensure the correct ducting is routed into your space when switching between the COOL, HEAT, and DRY functions. You may use any configuration with the FAN function. For HEAT and DRY modes, see page 22 for further instructions.

COOL MODE

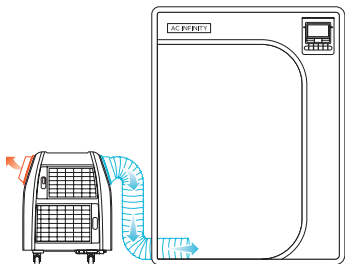

HEAT MODE

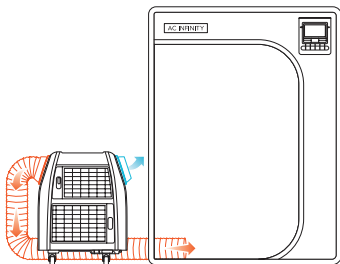

DRY MODE

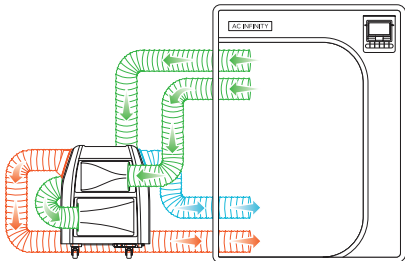

CONFIGURATION SETUP

DUCTWORK INSULATION

Condensation can form on the ducting if one is connected to vent B and it is used over an extended period in humid environments.

You may apply ductwork insulation to vent B to minimize the amount of condensation forming.

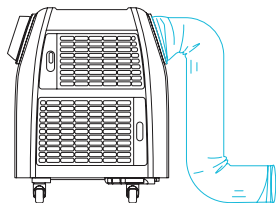

SELECTING ENVIRONMENTAL PRESSURE

How the intake/exhaust ducting are routed will determine the air pressure in your grow tent. Use the diagram below to help you route your ducting and airflow to your desired configuration.

- A. HEAT EXHAUST Vent**
- B. COOL EXHAUST Vent**
- C. HEAT INTAKE Vent**
- D. COOL INTAKE Vent**

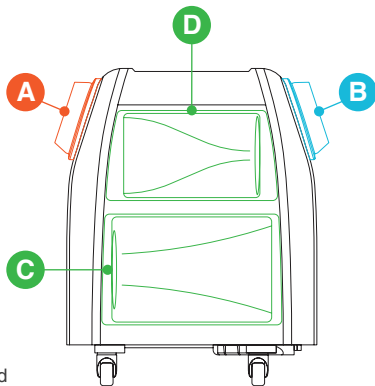

*Product shown with duct adapters attached

CONFIGURATION SETUP

SELECTING ENVIRONMENTAL PRESSURE

NEGATIVE PRESSURE

Negative pressure occurs when there is more air being pushed out than coming in. This creates a setup that prevents any inside air from mixing with the outside environment, but will allow outside air to enter your grow tent. This is useful for when you want to prevent any odors or airborne particles from escaping your grow tent. Note that the air in your grow tent will still be pushed out of any exhaust ducts that are creating the negative pressure.

INSTALLATION

Create negative pressure by routing ducting connected to vents B, C, and D into your grow tent as shown here. Use this configuration with the COOL function.

Heat your grow tent by connecting ducting to vent A and routing it into your grow tent. Point vent B away from it.

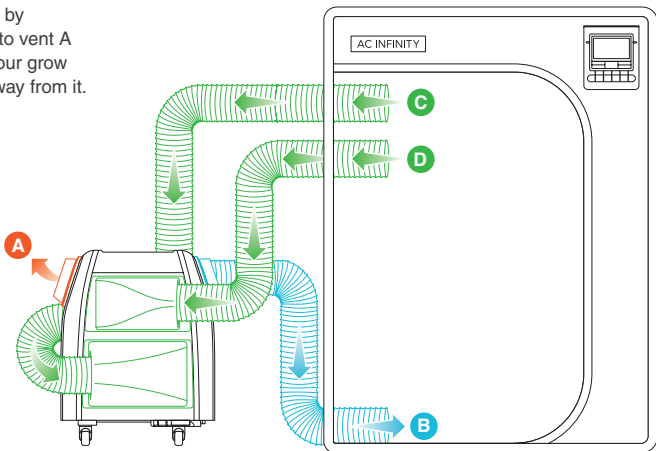

CONFIGURATION SETUP

SELECTING ENVIRONMENTAL PRESSURE

POSITIVE PRESSURE

Positive pressure occurs when there is more air coming in than being pushed out. This creates a setup that prevents outside particles from entering your grow tent, but will allow the air inside to escape. This is useful for when you want full control of the air coming from into your grow tent.

INSTALLATION

Create positive pressure by routing ducting connected to vent B into your grow tent as shown here. Use this configuration with the COOL function.

Heat your grow tent by connecting ducting to vent A and routing it into your grow tent. Point vent B away from it.

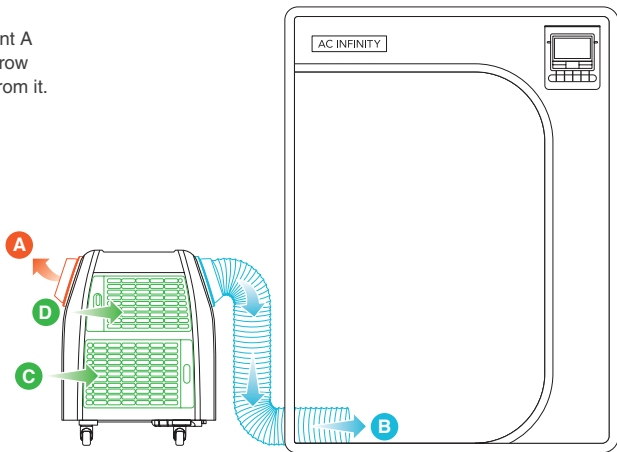

CONFIGURATION SETUP

SELECTING ENVIRONMENTAL PRESSURE

NEUTRAL PRESSURE

Neutral pressure occurs when the amount of air being pushed out is relatively equal to the amount of air blowing in. This creates a setup where very little air is exchanged between your grow tent and the outside environment.

INSTALLATION

Create neutral pressure by routing ducting connected to vents B and D into your grow tent as shown here. Use this configuration with the COOL function.

Heat your grow tent by connecting ducting to vent A and routing it into your grow tent. Point vent B away from it. Point vent B away from it.

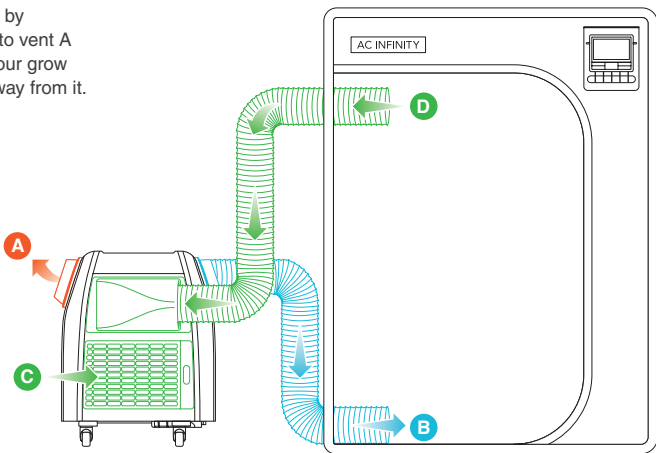

We recommend pairing the B and D cooling vents, or A and C heating vents, together to accelerate your desired temperature change while conserving the most energy.

INSTALLATION

INPUT ADAPTERS

BEFORE INSTALLATION

Only remove the adapters for periodic maintenance. Confirm your chosen configuration before setup to avoid unnecessary wear-and-tear. Do NOT operate your air conditioner while it is tilted, at an incline, or laid on its side.

STEP 1

Remove the evaporator and condenser frames as needed.

A. Push in the frame handle.

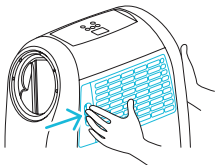

B. Pull the frame out.

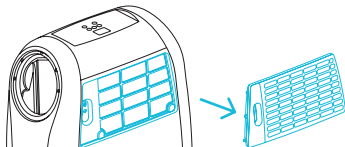

STEP 2—PROBE

Plug the sensor probe into the 3.5mm jack located at the top vent.

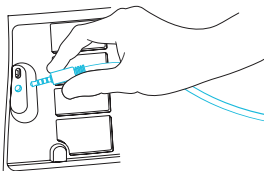

Plugging in the probe and extension cord is required before snapping in the evaporator duct adapter.

INSTALLATION

INPUT ADAPTERS

STEP 2—UIS™ EXTENSION CORD

Plug the UIS extension cord with the gasket connector into the UIS port at the top vent. The gasket is specially designed to protect against liquids and dust.

See the "Connecting to UIS" section for more information.

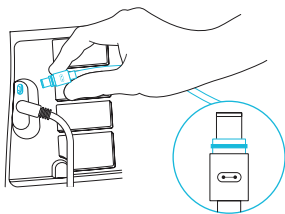

STEP 3

Snap the duct couplers onto the duct adapters. **DO NOT** remove the duct couplers once they are attached to the duct adapters.

This is a permanent attachment.
Attempting to remove the duct couplers
after installation may damage their clips.

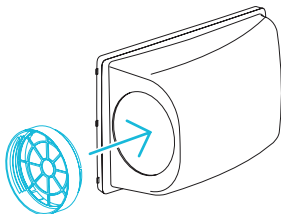

INSTALLATION

INPUT ADAPTERS

STEP 4

Before installation, make sure the sensor probe and UIS extension cord (as needed) are plugged in. Snap the evaporator duct adapter onto the top vent, making sure the connected cords route through the opening.

- A. Insert the flat fasteners at the front of the adapter into the corresponding openings.
- B. Once the front end of the adapter is attached, squeeze the back end towards the front, and then push in until you hear the clips click into place.

Only remove the adapter for periodic maintenance. See maintenance section for removal instructions.

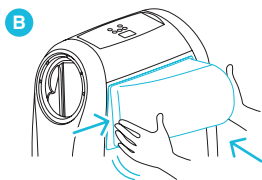
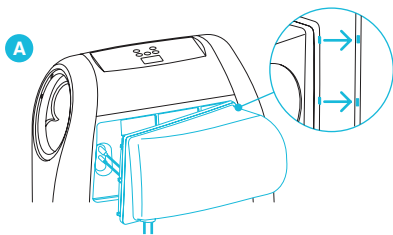

STEP 5

Snap the condenser duct adapter onto the bottom vent as needed.

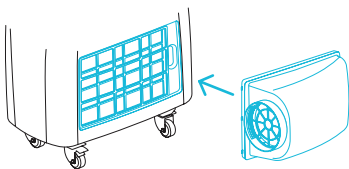

INSTALLATION

INPUT ADAPTERS

STEP 6

Extend the first few rings of ducting and screw the ducting onto the duct coupler.

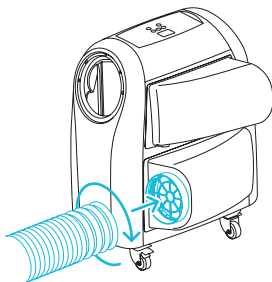

INSTALLATION

EXHAUST ADAPTER

STEP 1

Twist and pull off the shutter coupler from the top vent.

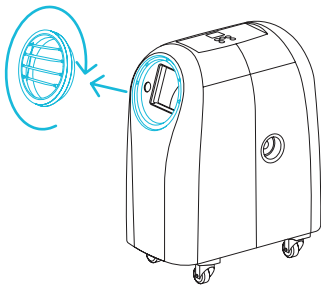

STEP 2

Screw the ducting onto the duct adapter base.

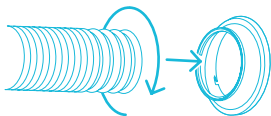

STEP 3

Screw the duct adapter base onto the top vent.

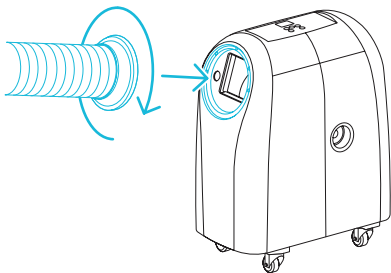

INSTALLATION

DRAIN PIPE

DRAINING THE TRAY

Your air conditioner is built with a condensation tray that will collect water and will need to be drained when it is full. Using the included drain pipe will direct the collected water to a drain or a catch tray. Please drain this tray completely after using or before moving your air conditioner.

DO NOT tilt, incline, or lay this product on its side or back. This will cause water to spill internally and pause programming until it is at an upright position.

Remove the drain cap and plug the drain pipe into the drainage hole. Route the drain pipe to a nearby drain or catch tray. Follow these steps before using the following modes:

HEAT/DRY MODE (Required)

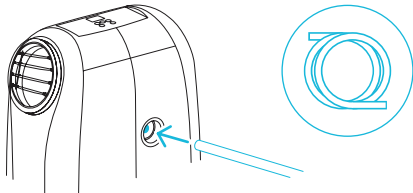

COOL MODE (Recommended)

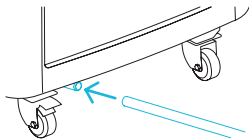

Ensure the drainage hole is properly capped while the drain pipe is not in use. This will prevent condensation from leaking.

Please note water may flow out of the drainage hole once it is uncapped. Set the drainage hole over a drain or catch tray.

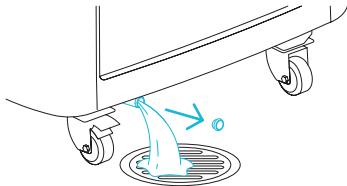

INSTALLATION

WINDOW DUCT KIT

OUTDOOR VENTILATION

Use the included window duct kit to help draw in fresh air or expel stale air.

STEP 1

Screw a flat head bolt into the main plate's mounting hole rail-side up.

Keep the bolt head parallel to the rails.

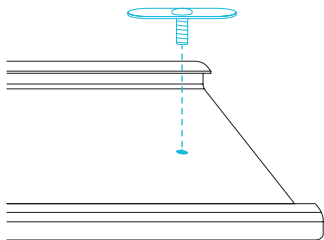

STEP 2

Apply a washer and wing nut onto the flat head bolt on the other side of the main plate.

Do not fully tighten the wing nut.

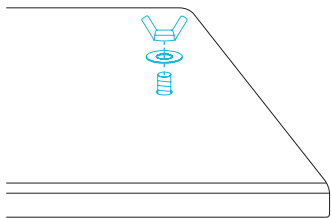

INSTALLATION

WINDOW DUCT KIT

STEP 3

- A. Slide the track plate into the main plate, making sure the flat head bolt enters its channel.
- B. Adjust the assembly to fit the height or width of your window. Tighten the wing nut once you have your desired length.

You may apply the second main plate to support additional ducting as needed.

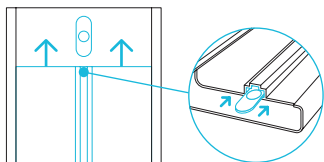

STEP 4

Place the assembly onto your window.

Close your window to hold the assembly in place.

The assembly can be installed horizontally or vertically, as shown.

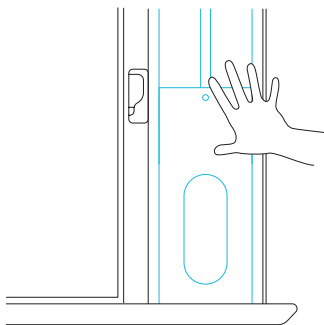

INSTALLATION

WINDOW DUCT KIT

STEP 5

Apply the seal tape along the track plate to cover and close off its gaps as needed.

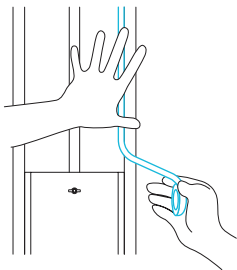

STEP 6

Screw the window duct adapter onto the ducting attached to your air conditioner's vents.

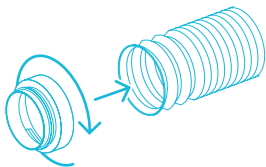

INSTALLATION

WINDOW DUCT KIT

STEP 7

Screw the window base coupler into the window duct adapter.

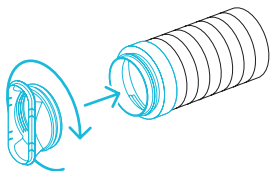

STEP 8

Snap the window base coupler to your window duct vent.

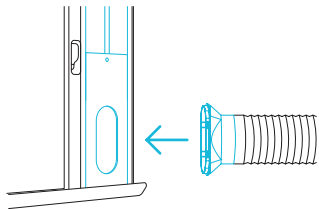

INSTALLATION

WINDOW DUCT KIT

VERTICAL SETUP

You may create an intake/exhaust configuration by using both included sets of window duct kits.

When configuring the window duct kits vertically, make sure the exhaust ducting is situated above the intake ducting.

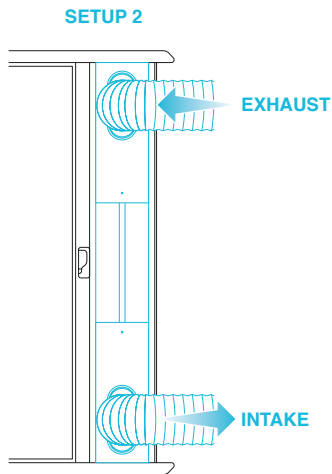
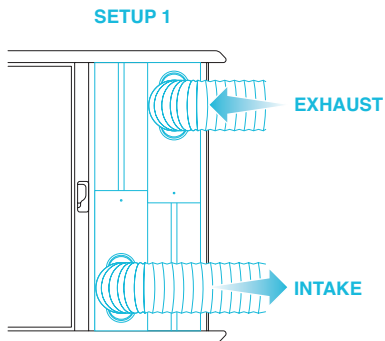

POWERING AND SETUP

POWERING YOUR AIR CONDITIONER

Plug your air conditioner into an AC power outlet to power it.

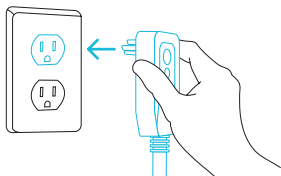

MAINTENANCE

STEP 1

Unplug your air conditioner.

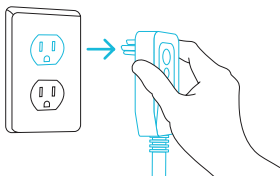

STEP 2

Lock the wheels and hold your air conditioner in place to prevent any movement.

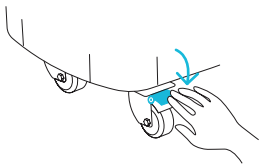

STEP 3

Firmly grip the vent end of the duct adapter while pushing the back end towards the vent end.

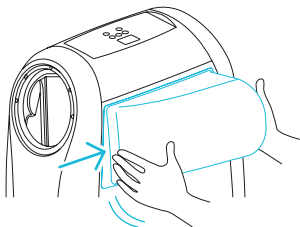

MAINTENANCE

STEP 4

While pushing in the back of the duct adapter, pull it out, starting from the back end.

Unscrew the ducting to better reach the coupler filters.

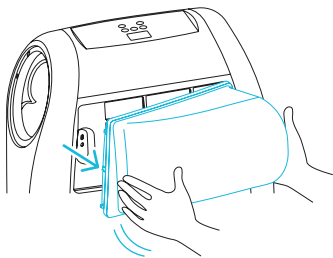

STEP 5

Wipe off any dust and debris from the grille and couplers using a damp cloth. Set aside to dry as needed.

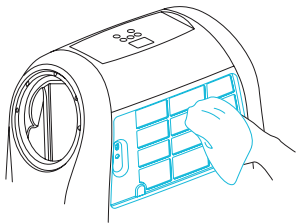

UIS™ PLATFORM

The UIS™ platform enables you to connect a single central controller with several grow devices simultaneously. By creating this fully integrated system, you can power and program all your devices together or separately for optimized grow tent management.

Your grow system can be regulated using your controller hub or remotely on the AC Infinity app (paired with compatible controllers), where you will have access to automation programming and climate data.

You can also connect your favorite grow light and outlet device to integrate them into the UIS platform using our RJ11/12 adapter and control plug module.

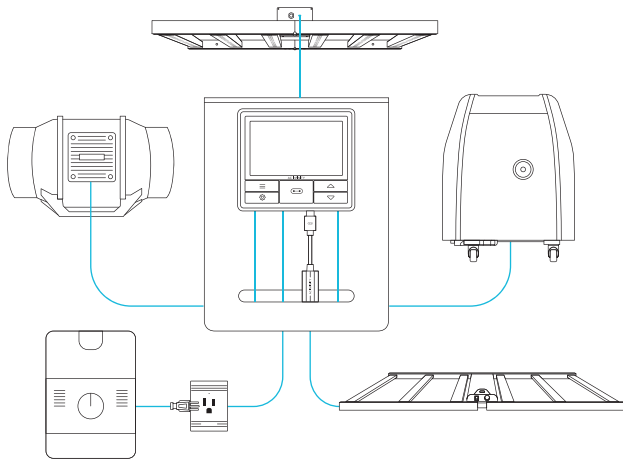

Grow devices will be sold separately and may still be in development at the time of your purchase of this product.

UIS™ COMPATIBILITY

MOLEX ADAPTER

Use the included Molex adapter to plug inline fans with 4-pin Molex connectors into this controller. Plug your fan's Molex connector into the adapter. Then plug the adapter into the controller.

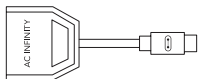

UIS M - 4PIN F
ADAPTER

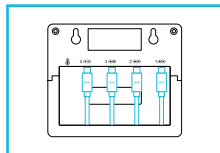

EXTENSION CABLE*

Use male-to-male UIS extension cords to connect devices with female UIS ports at an extended range from your controller. Included with UIS-compatible devices.

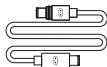

UIS M - M
CORD

EXPANSION SPLITTER*

The expansion splitter will allow you to connect 4 devices with a single port and can support additional splitters to create up to 3 tiers of expansion ports. Intended for exclusive use with AC Infinity controllers with UIS ports.

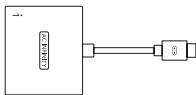

UIS M - F
4 PORT SPLITTER

*Not included

CONNECTING TO UIS™



The TERRAFORM Series can connect with any UIS controller (sold separately) as part of an integrated system using the included UIS extension cord.

EXTENSION CABLE

Use the included UIS M-M extension cord to connect your air conditioner to your UIS controller.

Plug the UIS extension cord with the gasket connector into your air conditioner. The gasket is specially designed to protect against liquids and dust.

Your UIS controller will override all onboard settings, assume control (parameters must be adjusted on the controller), and shut off your air conditioner's display and touch functions when connected in this manner. The sensor probe plugged into your controller will override the air conditioner's sensor.

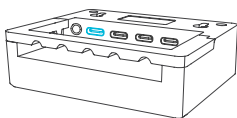
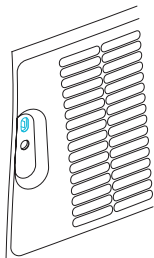
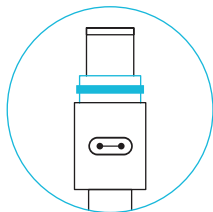

PROGRAMMING

1. MODE BUTTON

Cycles through the controller's modes: OFF, ON, AUTO, VPD, TIMER TO OFF, and CYCLE (ON and OFF)

2. UP/DOWN BUTTONS

Adjusts the value of your current mode. The up button increases and down button decreases the setting. Hold both to reset values to OFF/Default.

3. UNIT BUTTON

Cycles through the controller's functions: COOL, DRY, FAN, and HEAT.

4. SETTING BUTTON

Cycles through the controller's settings: °F / °C, CALIB. T° / H%, and LEAF OFFSET.

5. PROBE TEMPERATURE

Displays the current temperature that the probe is detecting. Shows "--" if no probe is plugged in. Includes a trend indicator that signals a rise, stability, or fall in temperature within the last hour.

6. PROBE VPD

Displays the current VPD that the probe is detecting (in kPa). Shows "--" if no probe is plugged in. Includes a trend indicator that signals a rise, stability, or fall in VPD within the last hour.



7. PROBE HUMIDITY

Displays the current humidity that the probe is measuring. Shows "--" if no probe is plugged in. Includes a trend indicator that signals a rise, stability, or fall in humidity within the last hour.

8. CONTROLLER MODE

Displays the controller's current mode. Pressing the mode button cycles through the available modes.

9. CURRENT LEVEL

Displays the current setting. Includes a trend indicator that signals if the setting is currently rising, falling, or holding steady.

10. USER SETTING

Displays the value of your current mode. Use the up or down buttons to adjust the value.

11. COUNTDOWN

Displays the countdown of the TIMER TO OFF or CYCLE Mode that activates or deactivates your air conditioner. TO ON shows the amount of time left before it turns on. TO OFF shows the amount of time left before it turns off.

12. ALERT ICONS

Displays alerts and statuses of the controller, including the controller lock, CLIMATE alert, and TIMER alert.

13. FUNCTION MODE

Displays the function your air conditioner is currently in: COOL, DRY, FAN, and HEAT.

14. VENT STATUS

Displays as a reminder to switch vent setups.

PROGRAMMING

FUNCTIONAL MODE

Press the unit button to cycle through the COOL, DRY, FAN, and HEAT functions. Ensure the programming does not cycle your air conditioner's activation in frequent, short intervals.

COOL

Use the COOL function to cool your space.

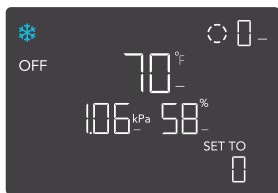

DRY

Use the DRY function to dehumidify your space.

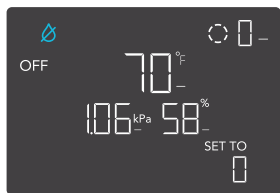

FAN

Use the FAN function to circulate air through your space

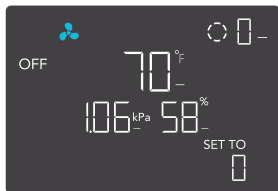

HEAT

Use the HEAT function to warm up your space.

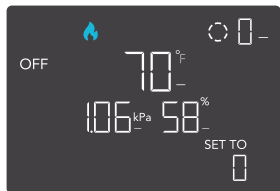

PROGRAMMING

ALL FUNCTIONS

OFF MODE

Your air conditioner will not run while in this mode. The OFF Mode setting also serves as the minimum level the other modes will run at while triggered OFF.

MINIMUM LEVEL

Your air conditioner will run at the level set in OFF Mode, as the minimum level, when triggered to turn OFF. These other modes include the AUTO Mode, VPD Mode, TIMER TO OFF, and CYCLE Mode.

It will run continuously until triggered ON, at which point they will run at the level set in ON Mode.

If you want your air conditioner to turn off completely when they're triggered to be OFF, set the OFF Mode level to zero.

Your air conditioner may take up to 3 minutes to exhaust hot or cold air when switching from OFF Mode.

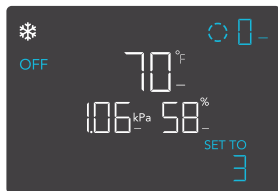
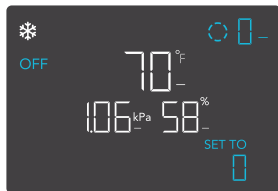

*Example shown



PROGRAMMING

ALL FUNCTIONS

ON MODE

Your air conditioner will actively run at the level set here, regardless of the probe's reading. The ON Mode setting also serves as the maximum level the other modes will run at.

MAXIMUM LEVEL

Your air conditioner will run at the level set in ON Mode, as the maximum level, when triggered ON, as well as in the AUTO Mode, VPD Mode, TIMER TO OFF, and CYCLE Mode.

Do not set the ON Mode figure to zero or Your air conditioner will turn off when it's triggered ON in all modes.

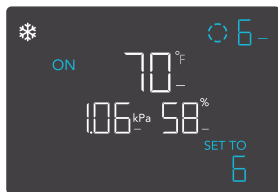

*Example shown

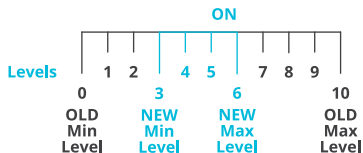

PROGRAMMING

COOL FUNCTION

CONTROLLER MODES

Pressing the mode button while in the COOL function will cycle through the available programming modes: OFF, ON, AUTO (high temp.), VPD (high VPD), TIMER TO OFF, and CYCLE (On and Off).

AUTO MODE (HIGH TEMPERATURE TRIGGER)

Pressing the up or down button sets the high temperature trigger. Your air conditioner will activate if the probe's reading meets or exceeds this threshold.

Once triggered, it will gradually ramp up to the level set in ON Mode. If the probe's reading falls below this trigger point, your air conditioner will gradually slow down to a stop or at the level set in OFF Mode.



HIGH TEMPERATURE TRIGGER POINT

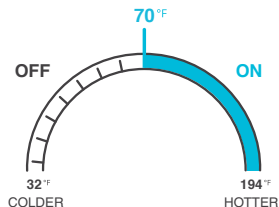

Set a trigger point to OFF if not in use, by holding down the up and down button. If there is a level set in OFF Mode other than zero your air conditioner will run at that level when triggered to turn off.

PROGRAMMING

COOL FUNCTION

VPD MODE (HIGH VPD TRIGGER)

Pressing the up or down button sets the high VPD trigger. Your air conditioner will activate if the probe's reading meets or exceeds this threshold.

Once triggered, it will gradually ramp up to the level set in ON Mode. If the probe's reading falls below this trigger point, your air conditioner will gradually slow down to a stop or at the level set in OFF Mode.

Set a trigger point to OFF if not in use, by holding down the up and down button. If there is a level set in OFF Mode other than zero your air conditioner will run at that level when triggered to turn off.

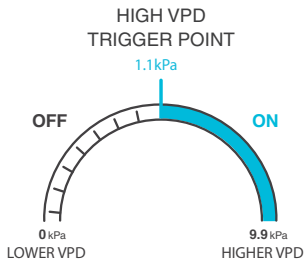
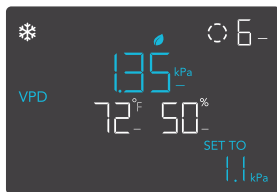

PROGRAMMING

COOL FUNCTION

TIMER TO OFF MODE

Pressing the up or down button sets a countdown time. During the countdown, your air conditioner will be set to ON. Once the timer ends, it will trigger to turn off. If there is a level set in OFF Mode, your air conditioner will run at that level after the end of the countdown.

The countdown will begin if no buttons are pressed for 5 seconds. The time left on the countdown is shown on the lower right corner of the display above the setting. Leaving the TIMER Mode while the countdown is running will pause it until you return to this mode.

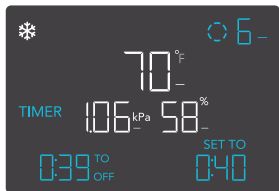

TIMER TO OFF
(COUNTDOWN END POINT)

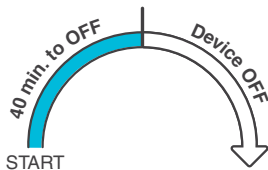

PROGRAMMING

COOL FUNCTION

CYCLE MODE (ON AND OFF)

Set an on duration and an off duration for your air conditioner to cycle through continuously. Press the up or down button to first set a duration for it to activate. Then press the mode button again and set a duration for it to deactivate.

When your air conditioner is activated, it will run at the level set in ON Mode. When it is deactivated, it will run at the level set in OFF Mode.

The countdown will begin if no buttons are pressed for 5 seconds. The time left on the countdown before the next ON or OFF phase is displayed below the current level. Leaving the CYCLE Mode while the countdown is running will pause it until you return to this mode.

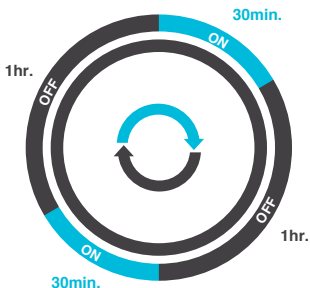

If there is a level set in OFF Mode other than zero, your air conditioner will run at that level when triggered to turn off.

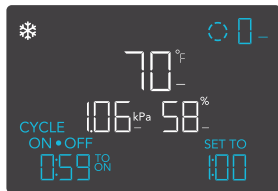
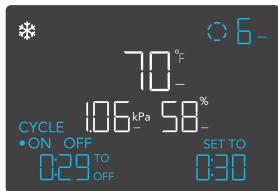

PROGRAMMING

DRY FUNCTION

CONTROLLER MODES

Pressing the mode button while in the DRY function will cycle through the available programming modes: OFF, ON, AUTO (high humid.), VPD (low VPD), TIMER TO OFF, and CYCLE (On and Off).

AUTO MODE (HIGH HUMIDITY TRIGGER)

Pressing the up or down button sets the high humidity trigger. Your air conditioner will activate if the probe's reading meets or exceeds this threshold

Once triggered, it will gradually ramp up to the level set in ON Mode. If the probe's reading falls below this trigger point, your air conditioner will gradually slow down to a stop or at the level set in OFF Mode.



Set a trigger point to OFF if not in use, by holding down the up and down button. If there is a level set in OFF Mode other than zero your air conditioner will run at that level when triggered to turn off.

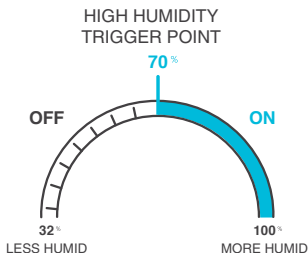

PROGRAMMING

DRY FUNCTION

VPD MODE (LOW VPD TRIGGER)

Pressing the up or down button sets the low VPD trigger. Your air conditioner will activate if the probe's reading meets or falls below this threshold.

Once triggered, it will gradually ramp up to the level set in ON Mode. If the probe's reading falls below this trigger point, your air conditioner will gradually slow down to a stop or at the level set in OFF Mode.

Set a trigger point to OFF if not in use, by holding down the up and down button. If there is a level set in OFF Mode other than zero your air conditioner will run at that level when triggered to turn off.

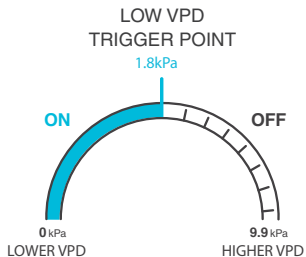
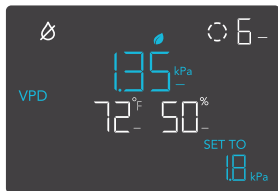

PROGRAMMING

DRY FUNCTION

TIMER TO OFF MODE

Pressing the up or down button sets a countdown time. During the countdown, your air conditioner will be set to ON. Once the timer ends, it will trigger to turn off. If there is a level set in OFF Mode, your air conditioner will run at that level after the end of the countdown.

The countdown will begin if no buttons are pressed for 5 seconds. The time left on the countdown is shown on the lower right corner of the display above the setting. Leaving the TIMER Mode while the countdown is running will pause it until you return to this mode.

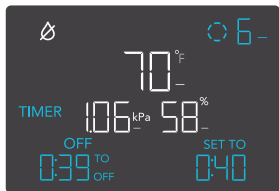

TIMER TO OFF
(COUNTDOWN END POINT)

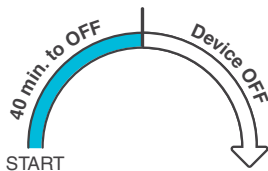

PROGRAMMING

DRY FUNCTION

CYCLE MODE (ON AND OFF)

Set an on duration and an off duration for your air conditioner to cycle through continuously. Press the up or down button to first set a duration for it to activate. Then press the mode button again and set a duration for it to deactivate.

When your air conditioner is activated, it will run at the level set in ON Mode. When it is deactivated, it will run at the level set in OFF Mode.

The countdown will begin if no buttons are pressed for 5 seconds. The time left on the countdown before the next ON or OFF phase is displayed below the current level. Leaving the CYCLE Mode while the countdown is running will pause it until you return to this mode.

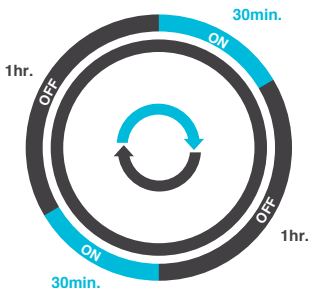

If there is a level set in OFF Mode other than zero, your air conditioner will run at that level when triggered to turn off.

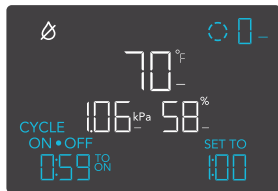
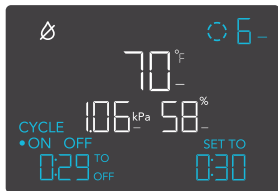

PROGRAMMING

FAN FUNCTION

CONTROLLER MODES

Pressing the mode button while in the FAN function will cycle through the available programming modes: OFF, ON, TIMER TO OFF, and CYCLE (On and Off).

TIMER TO OFF MODE

Pressing the up or down button sets a countdown time. During the countdown, your air conditioner will be set to ON. Once the timer ends, it will trigger to turn off. If there is a level set in OFF Mode, your air conditioner will run at that level after the end of the countdown.

The countdown will begin if no buttons are pressed for 5 seconds. The time left on the countdown is shown on the lower right corner of the display above the setting. Leaving the TIMER Mode while the countdown is running will pause it until you return to this mode.

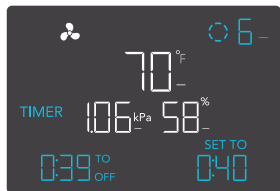

TIMER TO OFF
(COUNTDOWN END POINT)

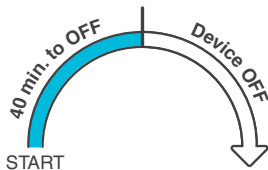

PROGRAMMING

FAN FUNCTION

CYCLE MODE (ON AND OFF)

Set an on duration and an off duration for your air conditioner to cycle through continuously. Press the up or down button to first set a duration for it to activate. Then press the mode button again and set a duration for it to deactivate.

When your air conditioner is activated, it will run at the level set in ON Mode. When it is deactivated, it will run at the level set in OFF Mode.

The countdown will begin if no buttons are pressed for 5 seconds. The time left on the countdown before the next ON or OFF phase is displayed below the current level. Leaving the CYCLE Mode while the countdown is running will pause it until you return to this mode.

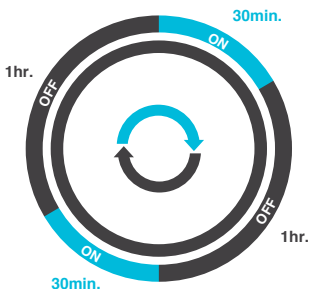

If there is a level set in OFF Mode other than zero, your air conditioner will run at that level when triggered to turn off.

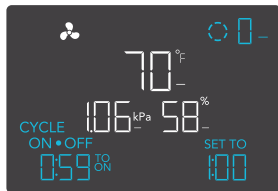
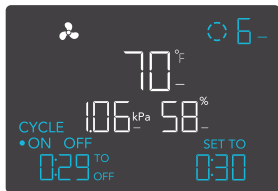

PROGRAMMING

HEAT FUNCTION

CONTROLLER MODES

Pressing the mode button while in the HEAT function will cycle through the available programming modes: OFF, ON, AUTO (low temp.), VPD (low VPD), TIMER TO OFF, and CYCLE (On and Off).

AUTO MODE (LOW TEMPERATURE TRIGGER)

Pressing the up or down button sets the low temperature trigger. Your air conditioner will activate if the probe's reading meets or falls below this threshold.

Once triggered, it will gradually ramp up to the level set in ON Mode. If the probe's reading rises above this trigger point, your air conditioner will gradually slow down to a stop or at the level set in OFF Mode.

Set a trigger point to OFF if not in use, by holding down the up and down button. If there is a level set in OFF Mode other than zero your air conditioner will run at that level when triggered to turn off.

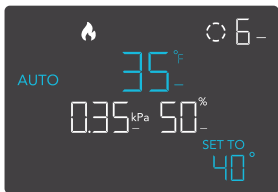

LOW TEMPERATURE TRIGGER POINT

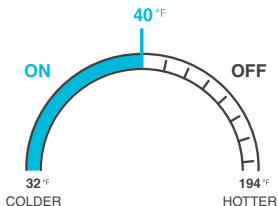

PROGRAMMING

HEAT FUNCTION

VPD MODE (LOW VPD TRIGGER)

Pressing the up or down button sets the low VPD trigger. Your air conditioner will activate if the probe's reading meets or falls below this threshold.

Once triggered, it will gradually ramp up to the level set in ON Mode. If the probe's reading falls below this trigger point, your air conditioner will gradually slow down to a stop or at the level set in OFF Mode.

Set a trigger point to OFF if not in use, by holding down the up and down button. If there is a level set in OFF Mode other than zero your air conditioner will run at that level when triggered to turn off.

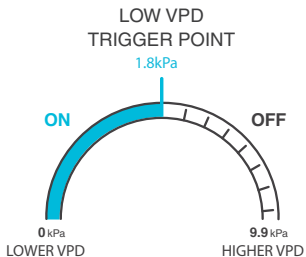
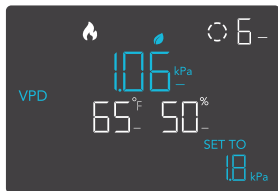

PROGRAMMING

HEAT FUNCTION

TIMER TO OFF MODE

Pressing the up or down button sets a countdown time. During the countdown, your air conditioner will be set to ON. Once the timer ends, it will trigger to turn off. If there is a level set in OFF Mode, your air conditioner will run at that level after the end of the countdown.

The countdown will begin if no buttons are pressed for 5 seconds. The time left on the countdown is shown on the lower right corner of the display above the setting. Leaving the TIMER Mode while the countdown is running will pause it until you return to this mode.

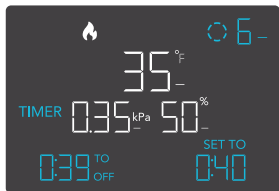

TIMER TO OFF
(COUNTDOWN END POINT)

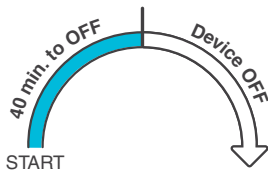

PROGRAMMING

HEAT FUNCTION

CYCLE MODE (ON AND OFF)

Set an on duration and an off duration for your air conditioner to cycle through continuously. Press the up or down button to first set a duration for it to activate. Then press the mode button again and set a duration for it to deactivate.

When your air conditioner is activated, it will run at the level set in ON Mode. When it is deactivated, it will run at the level set in OFF Mode.

The countdown will begin if no buttons are pressed for 5 seconds. The time left on the countdown before the next ON or OFF phase is displayed below the current level. Leaving the CYCLE Mode while the countdown is running will pause it until you return to this mode.

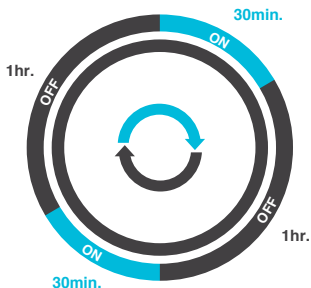

If there is a level set in OFF Mode other than zero, your air conditioner will run at that level when triggered to turn off.

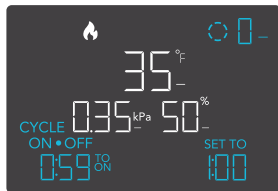
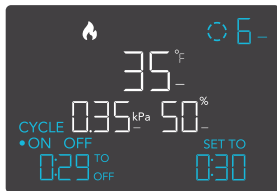

PROGRAMMING

CONTROLLER SETTINGS

Pressing the setting button will cycle through the controller's available settings: °F / °C, CALIB. T° / H%, and LEAF OFFSET.

TOGGLING THE DISPLAY

Lock the controller by holding the setting button.

Press the setting button to turn the display off. Pressing the setting button again will turn the display back on.

Programs will still run in the background while the LCD screen is off.

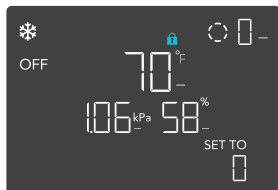

°F/°C SETTING

Changes the displayed units to Fahrenheit or Celsius. Press the up or down button to cycle through F and C. All displayed units will automatically convert when adjusting this setting.

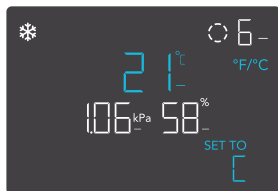

PROGRAMMING

CALIBRATION TEMPERATURE SETTING

Adjusts the temperature reading the sensor probe is measuring. Press the up or down button to increase or decrease the data figure in 1° increments. The calibration cycle ranges from -20°F to 20°F (or -10°C to 10°C) and will be applied to the sensor probe's measurements.

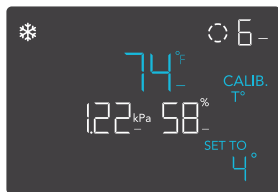

CALIBRATION HUMIDITY SETTING

Adjusts the relative humidity reading the sensor probe is measuring. Press the up or down button to increase or decrease the data figure in 1% increments. The calibration cycle ranges from -10% to 10% and will be applied to the sensor probe's measurements.

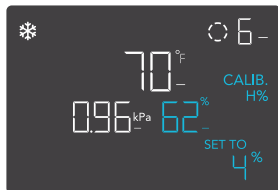

CALIBRATION LEAF OFFSET SETTING

Adjusts the VPD reading the sensor probe is measuring. Press the up or down button to increase or decrease the data figure in 1° increments. The calibration cycle ranges from -20°F to 20°F (or -10°C to 10°C) and will be applied to the sensor probe's measurements.

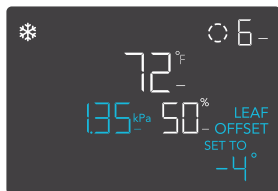

PROGRAMMING

ALERT ICONS

The alert icons are displayed at the top of the screen. Icons may flash when the controller signals an alert to notify you of any triggered function or alarm.

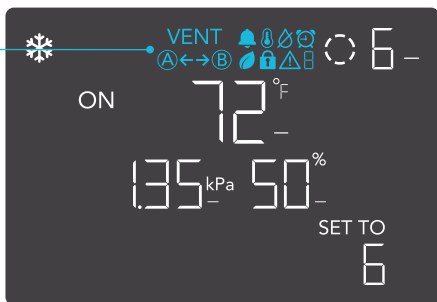

ALARM

Flashes and beeps with an alert if the temperature/humidity/VPD meets the trigger point set in the app.



AUTO MODE ALERT

Flashes whenever any of the AUTO Mode triggers (high temperature or low temperature) activate your air conditioner.



DRY ALERT

Flashes whenever any of the AUTO Mode trigger (high humidity) activates your air conditioner.



TIMER ALERT

Flashes when a countdown has completed for TIMER TO OFF or CYCLE Mode.

PROGRAMMING

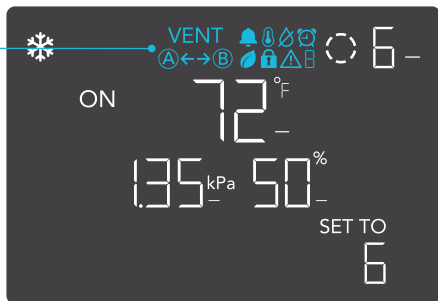

VENT ALERT

Displays whenever you switch between the COOL and HEAT functions to remind you to switch vent setups. See the Configuration Setup section for examples.



VPD ALERT

Flashes whenever either VPD Mode triggers (high VPD or low VPD) activate your air conditioner.



DISPLAY LOCK ALERT

Displays whenever you lock the controller. The icon will flash and beep if you attempt to adjust the controller while it is still locked.



ALERT

Flashes and beeps with an alert whenever your air conditioner experiences interference to its functioning. See the next page for possible issues.

PROGRAMMING

NUMBERED ALARMS

Alarms will trigger when your air conditioner experiences the following issues:



FULL CONDENSATION TRAY

Displays when the condensation tray is full. Empty the tray by opening the drainage hole beneath the condenser vent to drain the water. Your air conditioner will pause programming and its screen will flash until the water is emptied.



NO LONGER UPRIGHT

Displays whenever your air conditioner falls on its side or tilts. It will pause programming and its screen will flash until placed back at an upright position.



OVERCOOLING

Displays if your air conditioner's internal temperature falls too low. Its condenser will pause and cooling will be reduced until the internal temperature returns to safe levels. Your air conditioner will remain operational during this.



FAULTY SYSTEMS ALERT

Displays if your air conditioner detects a fault with its internal components. Please contact our customer service department or an HVAC technician for assistance.



ABNORMAL TEMPERATURES

Displays whenever your air conditioner detects an excessive temperature between your cooling and heating components. Turn it off for 30 minutes before turning it back on. Check for any errors and ensure the device is working properly.

If problems persist, please contact our customer service department at support@acinfinity.com or [626-923-6399](tel:626-923-6399) for product and warranty assistance.

OTHER SETTINGS

FACTORY RESET

Holding the mode, up, and down buttons together for 5 seconds will reset your controller and restore factory settings. This clears all user parameters in each controller mode and setting.

HOLD +



CONTROLLER LOCK

Holding the setting button will lock the controller in your current mode. While your controller is locked, no parameters may be adjusted, nor will you be able to switch modes. Holding the setting button again will unlock the controller.

HOLD +



HIDE SCREEN

Lock the controller so no settings can be adjusted. See above. Then press the setting button to turn the display off. Pressing it again will turn the display back on. Programs will still run in the background while the LCD screen is off.

PRESS +



JUMP TO OFF MODE

Holding the mode button for 3 seconds while in any mode or setting will automatically jump to OFF Mode. This function is disabled if the controller is locked.

HOLD +



OTHER SETTINGS

RESET TO OFF/DEFAULT

Holding the up and down buttons together for 2 seconds will reset the value of your current mode or controller setting to default. In AUTO or SCHEDULE Mode, pressing either the up or down button will return to its previous value.



AUTO INCREASING OR DECREASING

Holding the up or down button will increase or decrease the user setting automatically until you release them.



MUTE BUTTON SOUNDS

Hold the mode and up buttons to turn off button sounds.



FAQ

- Q:** Why does my screen turn off when I connect my air conditioner to a UIS controller?
- A:** A UIS controller will override your air conditioner's onboard programming. Your air conditioner's screen will shut off and you can program your device directly through the smart controller.
-

- Q:** When I connect to a smart controller, which sensor probe is active?
- A:** The sensor probe plugged into your controller will override the air conditioner's sensor.
-

- Q:** Can I place this air conditioner inside of my grow tent?
- A:** You may place your air conditioner inside of your grow tent as long as its humidity level does not rise above 65%. Otherwise we recommend keeping your air conditioner outside of your grow tent and directing air from it using the included ducting (as needed).
-

- Q:** Why isn't cold/hot air coming out of my air conditioner?
- A:** To preserve the integrity of the compressor, it may take up to 3 minutes for your air conditioner to exhaust hot or cold air when switching from OFF Mode. If no change occurs after 5 minutes of continuous operation, turn off the air conditioner and contact our customer service for assistance.

AC INFINITY PRODUCTS

Advance Grow Tents

The CLOUDLAB series is a line of grow tents designed to create ideal growing conditions and facilitate indoor plant cultivation year-round. Features 2000D thick oxford canvas lined with inner diamond patterned mylar that maximizes grow light luminosity, and a reinforced frame with 150 lb. weight capacity. Includes a mounting plate to install your AC Infinity controller onto.

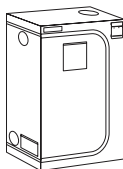

Inline Duct Fans

The CLOUDLINE series is a line of duct fans designed to quietly ventilate AV rooms and closets, as well as various DIY air circulation and exhaust projects. Features a thermal controller with intelligent programming that will automatically adjust duct fan speeds in response to changing temperatures.

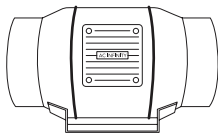

Grow Lights

A commercial level LED grow lamp designed to simulate outdoor daytime lighting with a richer light spectrum. Using the latest Samsung LM301H EVO diodes for unmatched intensity and efficacy, this LED grow system efficiently produces full-spectrum lighting to enhance all stages of the grow cycle.



Discover the latest innovations in environmental controls at acinfinity.com

WARRANTY

This warranty program is our commitment to you, the product sold by AC Infinity will be free from defects in manufacturing for a period of two years from the date of purchase. If a product is found to have a defect in material or workmanship, we will take the appropriate actions defined in this warranty to resolve any issues.

The warranty program applies to any order, purchase, receipt, or use of any products sold by AC Infinity or our authorized dealerships. The program covers products that have become defective, malfunctioned, or expressively if the product becomes unusable. The warranty program goes into effect on the date of purchase. The program will expire two years from the date of purchase. If your product becomes defective during that period, AC Infinity will replace your product with a new one or issue you a full refund.

The warranty program does not cover abuse or misuse. This includes physical damage, submersion of the product in water, incorrect installation such as wrong voltage input, and misuse for any reason other than intended purposes. AC Infinity is not responsible for consequential loss or incidental damages of any nature caused by the product. We will not warrant damage from normal wear such as scratches and dings.

Contact our dealers department at dealers@acinfinity.com or (626) 838-4656 for more information about our dealers and distributors program. Contact our customer service department at support@acinfinity.com or (626) 923-6399 for product and warranty assistance. Our business hours are Monday through Friday, 9:00 am to 5:00 pm PST.



If you have any issues with this product, contact us and we'll happily resolve your problem or issue a full refund!

COPYRIGHT © 2024 AC INFINITY INC. ALL RIGHTS RESERVED

No part of the materials including graphics or logos available in this booklet may be copied, photocopied, reproduced, translated or reduced to any electronic medium or machine readable form, in whole or in part, without specific permission from AC Infinity Inc.

www.acinfinity.com